

# Instruction Manual

## Trail Camera

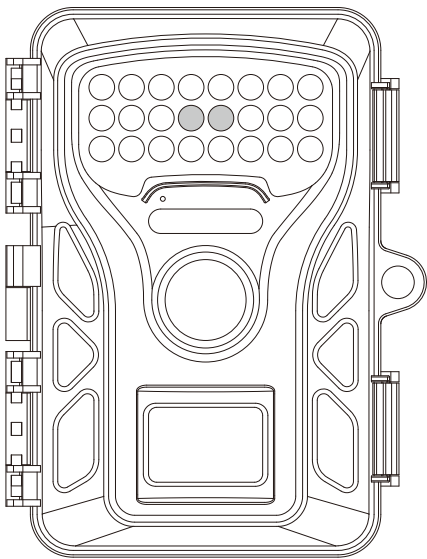

**48.0**

48 Megapixel

**IP66**

Waterproof

**2.0"**

IPS TFT-LCD

**0.4S**

Trigger time

**60°**

60° total  
PIR angle



4K Full HD  
Video function



**Dear customer, congratulations on purchasing a high quality product.**

You have purchased a Wildlife Camera with excellent technical features and respective accessory that is particularly easy to operate. Please study all notices carefully and diligently. Please study this information in detail observing, in particular, the safety instructions.

## **1. Contents of box**

**Carefully unpack camera and check that all of the following components are contained in the box:**

1. Wildlife Camera
2. Mounting belt
3. USB cable
4. Instruction manual



### **Note:**

- Remove the protective foil from the camera lens by pulling the protruding tab.
- Caution! Keep plastic foil and bags away from babies and small children, as otherwise danger of suffocation.

## 2. Contents

<b>1. Contents of box</b>	1
<b>2. Contents</b>	2
<b>3. Your camera</b>	3
3.1. Front view	3
3.2. Inside views	4
3.3. Viewscreen Indicators	5
<b>4. Quick start guide</b>	5
<b>5. Using the camera</b>	7
5.1. Mode switch	7
5.2. Settings	7
5.3. Aligning the camera	12
5.4. Setting up the Live mode	13
5.5. Night recording	14
5.6. File format	14
<b>6. Connecting to computer</b>	15
<b>7. Technical specification</b>	16
<b>8. Trouble shooting</b>	17
<b>9. System information, maintenance and disposal</b>	20
9.1. Care	20
9.2. Storage	20
9.3. Disposal	21

# 3. Your camera

## 3.1. Front view

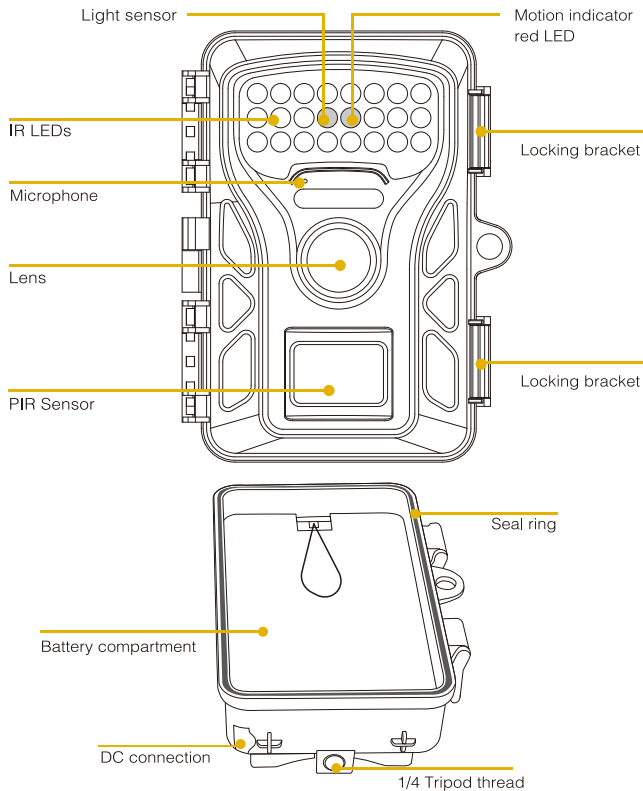

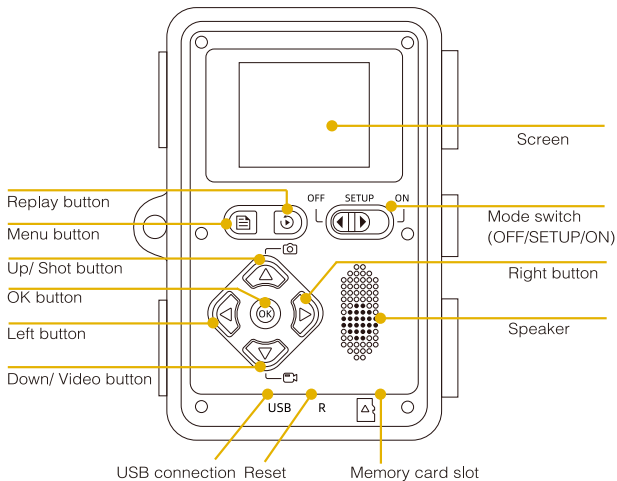

## 3.2. Inside views

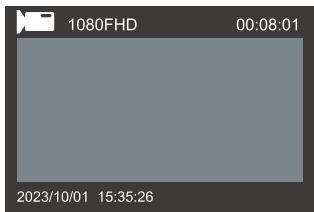
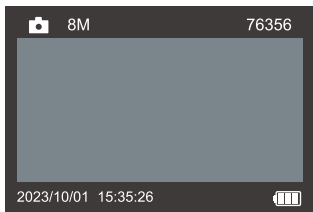

- The monitor is only switched on in the SETUP mode for changing menu settings or viewing existing photos.
- The TF memory card must have been inserted into the memory card slot in order to save photos.
- Using the mode switch the three operating modes OFF, SETUP and ON can be selected.

### 3.3. Viewscreen Indicators



	Photo/Video Mode
8M / 1080FHD	Current Image Resolution/Video Resolution
76356 / 00:08:01	Image/Video Capacity Left
	AA Alkaline Battery Usage Icon
2022/06/01 15:35:26	Date and Time

## 4. Quick start guide

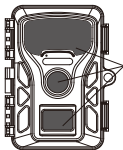

1. Remove the protective plastic covers from the camera lens, and PIR sensor.

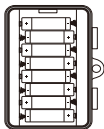

2. Open the battery cover to install 8 AA batteries (Energizer Rlithium batteries are recommended. Alkaline batteries may be used but battery life will be shorter. Rechargeable batteries are not recommended.) Be sure to position the batteries for correct polarity (+/\_ ) when installing.



3. Install a new SD card, up to 128GB. High speed cards (class 10 or above) are recommended if you plan to record video clips. The new SD card are recommended to format with the camera before usage.



4. At the location where you will place the camera, move the power switch to the ON position. The camera's default settings were chosen for typical usage as a scouting camera for hunters. Photo mode at 8MP resolution, with a 30 second interval between photos, and "Medium" PIR sensitivity. These settings may be easily changed to suit your individual preferences or application (for example, if you would rather capture videos, or photos at a different resolution, spaced further apart), using the app on your smartphone or menu in the camera. (Moving the power switch to the "SETUP" position)

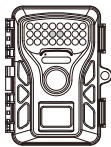

①

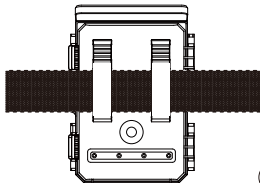

②

5. Mount the camera using the provided tree strap or 1/4"-20 mounting socket.

**Now your camera is ready to use.**



## 5. Using the camera

Prior to setting up the camera for surveillance, it must be set up for the respective purpose. For this purpose, there is a setup mode available. In addition to changing settings, photos and videos can be taken and existing photos can be viewed in this mode.

### 5.1. Mode switch

Open the camera as described in section 6.1. The Mode switch is located at the bottom edge on the left inside. 3 operating modes can be selected:

**OFF:** The camera is completely switched off in the OFF mode.

**SETUP:** Select SETUP mode to adjust settings and make or playback photos and videos.

**ON:** The camera is activated to take photos automatically (Live mode).

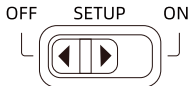

### 5.2. Settings

Prior to using the Wildlife Camera, change the settings as required. Slide the mode switch of the Camera to the SETUP position to start the setup mode. In the Photo or Video mode press the MENU button to call up the menu. All menu options of the Camera and possible setting values for the recording mode are listed below. The standard setting is always highlighted in bold.



- **Photo pixel:** 48M/30M/25M/20M/16M/12M/**8M**/5M Available.

Select the desired resolution for photos. A higher resolution produces a somewhat better photo quality but results in larger files requiring more space on the memory card.

- **Sequence:** 1 shot /2 shot /3 shot available.

Default 1shot. Select the number of photos to be taken in succession when the camera is triggered in the Photo mode. Please also observe the parameter Interval!



Video

- **Video Resolution:** 4K/2K/1080FHD/720P.

Select the required video resolution. A higher resolution produces higher quality videos but results in larger files, which require more space on the memory card. Videos are recorded in AVI format, which can be played back on most video devices.

- **Recording Length**

Default 10 seconds, press up and down button to choose recording length. Optional 10s-180s. Set the video recording length when the camera is triggered automatically.

In the SETUP mode during the day and at night.

- > When recording manually, the camera will automatically stop after 29 minutes of recording.
- > When recording manually, the camera will stop when the size of one video clip reaches 4 GB.
- > When recording manually, the camera will stop when the memory card is full or when the power is low.

In live mode (ON)at night, the camera will automatically function according to the video length setting. For low power, it will stop recording. Please set the shorter video length in advance to ensure longer battery life.



**Notice:**

- Video recording will consume significantly more power than taking photo, especially at night with IR LED on. Please set a shorter video length to ensure battery life. The power consumption of 10 seconds video recording is the same as 150 photos.

- **Record Audio:** Off/On
- **Audio Volume:** low/medium/high  
Adjust video playback volume.



Setup

- **Capture, Video, Capture+ Video.** "Capture" is used for taking photos, while "Video" is used for recording videos. When you choose "Capture+ Video," the camera is capable of both capturing photos and recording videos. It follows a sequence where it captures a photo first and then proceeds to record a video.
- **Operate Interval**  
Defaulted 30seconds, optional from 5seconds ~30minutes  
The PIR Interval option lets you set the time between captured images when an animal remains within the camera's sensor range after it is first detected and the camera is triggered. The camera does not record any images or videos during the selected interval. This prevents the memory card from being filled with unnecessary shots.



**Note:**

- The interval time is short, the camera shooting frequency would be high, and there would be high consumption of batteries. It would effect the usage days of the batteries. It is just on the opposite ,the interval time is long, would be a lower consumption of batteries to guarantee a longtime usage.
- **Time lapse: Off/On**  
When "on" has been selected, the camera would automatically take photos/videos in the selected time interval, irrespective of whether or not the PIR sensor has detected a motion or not. This is useful for observing cold blooded animals e.g. snakes or plants opening up, etc.

As soon as the "On" setting has been confirmed by pressing the **OK** button you can enter the interval time after which photos/videos are to be taken.



**Note:**

- In this mode, the PIR function would stop working, and the camera would take photos/videos in the setting interval time.
- **Timer: Off/On**  
Select "ON" to establish a monitoring period. After completing the setup, the camera operates exclusively during a specific timeframe each day. Outside this period, the camera remains in standby mode. For example, if the start time is set to 18:35 and the end time to 8:25, the camera will function from 6:35 pm of the current day until 8:25 am of the next day. Beyond this specified period, the camera will not be triggered and will not capture any photos or videos.
- **Date/Time**  
To modify the Date/Time setting, select Date/Time and press OK. Utilize the UP and Down buttons to adjust values, and use the left or right buttons to navigate to the next setting item. Press the Menu button to exit the Date/Time setting.
- **Time Stamp: On/Off**  
Selects whether the user wants to have the Time and Date stamped on images. The default mode is ON.
- **Format: Cancel/OK**  
Deletes(erases) all files stored on a card to prepare it for reuse. Always format a card that has been previously used in other devices.
- **Default setting(Reset to factory): Cancel/OK**  
Restores all settings to the factory defaults.
- **Screen Saver: Off/1 Minutes/3 Minutes**
- **Auto Power Off: Off/3 min/5min/10 min**  
The LCD monitor would automatically turn off after the setting time.

- **Economy Mode: Off/On**

If turned on, files taken at night under low battery conditions will be completely black images.

- **Beep Sound: On/Off**

- **PIR Sensitivity: High/Medium/Low**

> When set to "High", the PIR sensitivity is at its maximum, and the detection range is farthest.

> When set to "Medium", the PIR sensitivity is moderate, and the detection range is average.

> When set to "Low", the PIR sensitivity is relatively low, and the detection range is shorter.



**Note:**

- This mode setting will impact the PIR detection range and sensitivity; please adjust this setting carefully.

- **Loop Recording: Off/On**

If you plan to deploy this product in the field for an extended period and the memory card capacity is limited, you can enable this function. When you select "On," the camera will overwrite previous files, allowing the memory card to continuously store new recordings.

- **Password Setting: Off/On**

After selecting "On" enter a four digit password to protect your camera against unauthorized access.

This password must be entered each time the camera is switched on in the SETUP mode before the camera can be used.



**Note:**

- If you forgot your password, please unlock the camera with password "OPEN".



- **Serial ID Set: Off/On**

Click and select "ON" to assign a name for the camera, and it will be displayed in the photo watermark.

- **Language:** Select the desired menu language

The following languages are available: English, German, French, Spanish, Chinese, etc.

- **Version:** You can check the software version.

- **Replay mode:** Press the PLAYBACK button  to enter the playback interface. Then, press the menu button  to delete the files.

- **Delete:** Select the "Delete" option to remove individual or all photos and videos from the memory card thus making storage room for new photos and videos.
- **Delete Current:** Using this option you can delete individual photos and videos. After selection the option by pressing the OK button, the photo and video to be deleted is shown. Confirm deletion by selecting "OK" and confirming the selection by pressing the OK button. To end the deletion process, select "Cancel" and confirm by pressing OK.
- **Delete All:** Select option "All" to delete all photos and videos on your memory card. To confirm deletion of all your photos and videos, select "OK" and press the OK button. Select "Cancel" to interrupt the deletion operation.

### 5.3. Aligning the camera

The Test mode is advantageous for determining the best possible detection angle and range of the movement sensor. For this purpose attach the camera at approx. 1-2 m height to a tree and align the camera with a desired direction. Move slowly from one side of the observed area to the other. Move parallel to the camera. Try out different angles and distances.

- The red LED on the front of the camera indicates that you were detected by a central sensor zone.

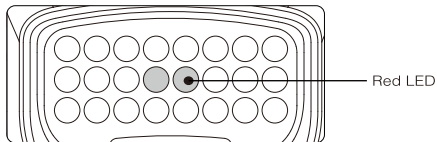

In this way you can determine the best position for aligning the camera. The LED only lights up in the SETUP mode as soon as one of the sensors has detected movement. The LEDs do not light up when in Live mode.

In order to prevent incorrect signals and unnecessary photos, we recommend not using the camera at sunny points and check that no branches are in the active area of the sensor. Optimum alignment is in North or South direction. The detection range of the sensors is approx 60°.

Also check that the camera is set to the correct height in line with the point to be observed. Where necessary, point the camera down for optimum alignment.



#### Note:

- Wildlife Camera corresponds to protection class IP 66. The camera is protected against dust and spray water and can thus be used in any weather condition.

## 5.4. Setting up the Live mode

The standard application of the Wildlife Camera is the Live mode. When in this mode, photos are either triggered by movement sensors or at intervals according to the respective setting.

To set up the Live mode, switch mode switch to ON position.

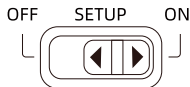

The red status LED flashes for approx. 5 seconds after which the camera operates automatically and enters the Standby mode.

As soon as wild animals or other objects directly enter the detection area of the central sensor zone, the camera starts to record photos and videos.

## 5.5. Night recording

During night recording the infrared LEDs (IR LEDs) at the front of the Wildlife Camera provide the light required for taking photos. Wildlife Camera uses IR LEDs with a long wavelength, to keep red light to a minimum.

The provided number of IR LEDs generates a high deflection angle thus allowing night recording at a distance of 3 m to 20 m, without overexposing the object. Reflecting objects can, however, also cause overexposure within this range (e.g. road signs).

Please note that night recording using IR LEDs produces black and white images.

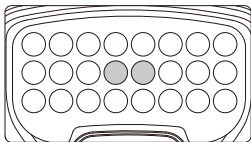

## 5.6. File format

The Wildlife Camera stores photos and videos on the memory card in the folder "\DCIM\ MOVIE&PHOTO".

Photos are given a file name with extension "JPG"(Example: "IMAG0001.jpg"), videos, are given the extension ".avi" (Example: "IMAG0001.avi").

When in SETUP and OFF mode use the enclosed USB cable to transfer files onto the computer. Alternatively you can insert the memory card in a card reader on the computer.

The video file can be played with most standard programs, such as Windows Media Player, QuickTime etc.



## 6. Connecting to computer

The Wildlife Camera can be connected to a computer using the supplied USB cables to view existing photos/videos.

### System requirements

Windows	Macintosh
<ul style="list-style-type: none"><li>■ Pentium III or higher</li><li>■ Windows XP/Vista/7/8</li><li>■ 512 MB RAM</li><li>■ 1GB available hard disk space</li><li>■ Screen resolution 1.024 x 768 or higher</li><li>■ Available USB connection</li></ul>	<ul style="list-style-type: none"><li>■ PowerPC G3/G4/G5</li><li>■ OS 10.3.9 or newer system</li><li>■ 512 MB RAM</li><li>■ 1GB available hard disk space</li><li>■ Screen resolution 1.024 x 768 or higher</li><li>■ Available USB connection</li></ul>

1. Connect the camera to your computer using the USB cable.
2. The camera switches on automatically in the USB mode, irrespective of the selection on the mode switch.
3. The camera installs itself on the computer as an additional drive under the name "Removable storage device".
4. Double click on the device to detect the folder "DCIM".
5. The photos and videos are located in the sub folders of the "DCIM" folder.
6. You can copy or move photo and video files on the computer. Alternatively you can insert the memory card in a card reader on the computer.

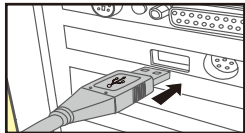

### Note:

- Mac computers show an "Unknown" drive on the desktop. When clicking on this drive, the program "iPhoto" is automatically started.

## 7. Technical specification

Lens	f=4.0mm F/NO=2.0 FOV=90°
Picture Resolution	48M: 8000x6000; 30M: 7392x4160; 25M: 6800x3824; 20M: 6192x3488; 16M: 5392x3040; 12M: 4688x2640; 8M: 3792x2144; 5M: 3008x1696; 2M: 1920x1080
Video resolution	4K(3840 x 2160@30fps); 2K(2560 x 1440@30fps); 1080P(1920 x 1080 30fps); 720P(1280 x 720 30fps)
Video Format	JPEG/AVI(MJPEG)
Display Screen	2.0" color TFT LCD
Trigger distance	65ft/20meters
Trigger time	approx. 0.4 second
Detection angle	60°
IR flash range	65ft/20meters
Functions	Multishot 1 to 3 images, interval 5 sec. to 60 min., video length 10 sec.to 3 min, interval recording, timer, password protection, image info stamp, low battery alarm
Memory	SD / SDHC memory card up to 128 GB
Connectors	USB type-c
IP class	IP66 Waterproof
Operating Temperature	-20 - 60°C
Storage temperature	-30 - 70°C
Operating Humidity	5% - 90%
Dimensions	approx. 135 x 103 x 70 mm
Weight	approx. 260 g



### Note:

- Design and technical specification are subject to change.

## 8. Trouble shooting

### Camera won't power up?

- Make sure that you have installed all four batteries in the battery compartment, filling all four battery spaces with no "gaps". We recommend using Energizer Lithium AA batteries in our camera.
- Make sure that the batteries are installed correctly, observing proper polarity. Always place the negative (flat) end of each battery in contact with the spring side of its slot inside the camera.
- Press the "R" reset button at the bottom of the camera to restart the camera.

### Camera stops taking images or won't take images?

- Please make sure that the SD card is not full. If the card is full, the camera will stop taking images.
- Check the batteries to make sure that they are new alkaline or lithium AA batteries. See previous notes about short battery life.
- Make sure that you are using a good quality SD card in your camera. We recommend SanDisk SD Cards up to 32GB. If the SD card has its write protect switch in the lock position, the camera will not take images.
- If you have used an SD card in another device before inserting it in our camera, you might want to try formatting the card by using our camera. In some cases, other devices may change the formatting of the SD card so that it will not work properly with our camera.
- Press the "R" reset button at the bottom of the camera to restart the camera system in the condition of SD card and battery are installed correctly.

## Camera takes continuous images of no subject?

A camera has what is known as a “false trigger” if the PIR sensor thinks that there is motion and heat in front of the camera lens when there is no subject in the image. These “False Triggers” are the result of placing the camera in an environment where there is motion associated with tree branches creating motion in front of the camera or an area where there is high heat in the foreground and any motion from wind could set off the camera. Setting a camera up over water is also a potential cause for this issue. To remedy this situation:

- Try moving the camera to an area that does not have any of these issues or try changing the sensor level on the menu settings.
- If the camera continues to take images when there is no subject in them, try placing the camera in an inside environment and aiming at a location where there is no motion.
- If the camera continues to show issues, then there is probably an electronic component issue. If this is the case, please contact our customer service to send the camera back for repair.

## Battery life is shorter than expected?

- The setting you select for “Operate interval” and “Video Length” in the Setup Menu will have a significant impact on battery life. Shorter interval time and long video length setting are all lead to short battery life. We suggest to go with the defaulted setting of Interval time 30SEC or above, and the video length within 10sec.
- Battery life will vary with operating temperature and the number of images taken over time. Typically, the Camera will be able to capture several hundred images before the batteries die.
- Check to make sure you have used new alkaline or lithium batteries. We recommend using Energizer Lithium AA batteries (full set of 4) in your camera to obtain maximum battery life.
- Make sure that you are using a good quality name brand SD card in your camera. We recommend SanDisk brand SD Cards up to 32GB. Our experience indicates that poor quality SD cards can sometimes reduce your camera battery life.

## Still photo and/or video quality problems?

1. Night photos or videos appear too dark.
  - Check the battery indicator icon to see if battery power is full. The flash will stop operating near the end of the battery life.
  - You will get the best results when the subject is within the ideal flash range, no farther than 15 meters from the camera. Subjects may appear too dark at greater distances.
2. Daytime photos or videos appear too dark.
  - Make sure that the camera is not aimed directly at the sun or other light sources during the day, as this may cause the camera's auto exposure to produce darker results.
3. Daytime photos or videos appear too bright.
  - Make sure that the camera is not aimed near an extremely dark area during the day. The auto exposure may "overcompensate" by lightening the image too much.
4. Short video clips—not recording to the length set.
  - Check to make sure that the SD card is not full.
  - Make sure that the camera has good batteries in it. Near the end of the battery life, the camera may choose to record shorter video clips to conserve power.

## Photos do not capture subject?

- Check the "PIR SENSITIVITY" parameter setting (SETUP menu). For warm temperature conditions, set this to "HIGH" and for cold weather use, set the PIR sensitivity to "LOW". For variable weather, use "MEDIUM".
- Try to set your camera up in an area where there is not a heat source in the camera's line of sight.
- In some cases, setting the camera near water will make the camera take images with no subject in them. Try aiming the camera over ground.
- Try to avoid setting the camera up on small trees that are prone to being moved by strong winds.
- Remove any limbs which are right in front of the camera lens.

## **PIR sensor led flashes/doesn't flash?**

- When the camera is in the "Setup" mode, a special LED on the front of the camera will flash when it senses motion. This is for setup purposes only and will help the user aim the camera.
- During use, the LED will not visibly flash when the camera takes an image. The LED array uses infrared light to help keep the camera hidden from game.

## **Display screen comes on but then powers off?**

- The display automatically turns off if no control keys are pressed for 30 seconds, to conserve battery power.

# **9. System information, maintenance and disposal**

- Microsoft® and Windows® are trademarks of Microsoft Corporation registered in the US.
- Pentium® is a registered trademark of Intel Corporation. Macintosh is a trademark of Apple Computer Inc.
- SD™ is a trademark.

## **9.1. Care**

Do not use any corrosive cleaners, such as methylated spirits, thinners, etc. to clean the camera housing and supplied accessory. When required, the clean system components with a soft dry cloth.

## **9.2. Storage**

Always remove the battery from the housing if the camera is not being used for some time and store the battery separately. On a day to day basis and over longer periods the batteries can be kept at a dry location out of the reach of children.

### 9.3. Disposal

For disposal, separate packaging into different types and dispose of in line with environmental regulations in supplied collection containers. Batteries and storage batteries may not be disposed of in domestic waste. Consumers are obliged by law to return used batteries to communal collection points or dealers selling batteries. Storage batteries and batteries do therefore contain the adjacent symbol.

Correct disposal of product:

The adjacent symbol indicates that electrical and electronic equipment may not be disposed of in domestic waste in the EU. Please use the returns and collection points of your local council or contact your dealer you purchased the product from. This prevents potentially harmful effects on the environment and health as a result of incorrect disposal. For further information contact the respective department of your local council.

